



Implant Direct Sybron Manufacturing, LLC
3050 East Hillcrest Drive, Thousand Oaks, CA 91362 USA
Toll Free: 888-649-6425, Direct: 661-705-4920, www.implantdirect.com

Instructions For Use

(Spectra-System, ScrewPlant, ScrewPlus, ScrewIndirect, ScrewDirect, ScrewRedirect, GoDirect, Legacy, RePlant, RePlus, ReActive, SwishPlant, SwishPlus, SwishActive and InterActive Systems)

Caution:

Federal law restricts this device to sale by or on the order of a dentist.

Small diameter implants and angled abutments are not recommended for the posterior region of the mouth.

For short implants, clinicians should closely monitor patients for any of the following conditions: peri-implant bone loss, changes to implant's response to percussion, or radiographic changes in bone to implant contact along the implant's length. If the implant shows mobility or greater than 50% bone loss, the implant should be evaluated for possible removal. If the clinicians choose a short implant, then clinicians should consider a two-stage surgical approach, splinting a short implant to an additional implant, and placement of the widest possible fixture. Allow longer periods of osseointegration and avoid immediate loading.

Disclaimer of Liability:

The users of Implant Direct Sybron Manufacturing, LLC. products must determine whether or not a particular product is suitable for a particular application and circumstance. Implant Direct Sybron Manufacturing, LLC. disclaims any liability, express or implied, and shall have no responsibility for any direct, indirect, punitive or other damages arising out of or in conjunction with any errors in professional judgment or practice in the use of Implant Direct Sybron Manufacturing, LLC. products. Users are advised and obliged to study the latest news and developments in implant dentistry, and to frequently review www.implantdirect.com for any updates to products and/or specifications. Implant Direct Sybron Manufacturing, LLC. has no control over the use of its products, which are the responsibility of the user. Implant Direct Sybron Manufacturing, LLC. assumes no liability whatsoever for damage arising thereof.

DENTAL IMPLANTS

1: *Indications For Use, General:* Implant Direct Sybron Manufacturing, LLC.'s dental implant product line consists of one-piece and two-piece implants for one-stage or two-stage surgical procedures. These implants are intended for use in partially and fully edentulous upper and lower jaws in support of single or multiple-unit restorations and terminal or intermediate abutment support for fixed bridgework.

Implants can be indicated for immediate loading when good primary stability has been achieved and with appropriate occlusal loading.

- **ScrewDirect Implants:** Indicated for single-tooth replacement of mandibular central and lateral incisors and maxillary lateral incisors. Is also indicated for multiple tooth replacements or denture stabilization. Wider diameter implants can be used in the upper and lower posterior. For cemented restorations only.
- **ScrewRedirect Implants:** Indicated for the support and retention of fixed single or multiple-tooth dental prosthesis. ScrewRedirect is indicated for immediate functional loading when four or more implants are splinted together in the edentulous upper or lower jaw.
- **ScrewIndirect Implants:** Indicated for the support and retention of bar overdentures or as a terminal or intermediary attachment for screw-retained fixed bridgework. Indicated for immediate functional loading when four or more implants are splinted together in the edentulous upper or lower jaw.

- Narrow Diameter (3.0, 3.2, 3.3mm) Implants: Indicated for single-tooth replacement of mandibular central and lateral incisors and maxillary lateral incisors. Also indicated for multiple tooth replacements or denture stabilization.

2: Compatibility:

- ScrewPlant, ScrewPlus, ScrewIndirect, ScrewDirect, ScrewRedirect & GoDirect Systems: Surgically compatible with Zimmer Dental Tapered Screw-Vent drills.
- Legacy System: Surgically and prosthetically compatible with Zimmer Dental Tapered Screw-Vent system. Also prosthetically compatible with BioHorizons and MIS implants.
- RePlant System: Surgically and prosthetically compatible with Nobel Biocare NobelReplace tri-lobe system.
- RePlus & ReActive Systems: Prosthetically compatible with Nobel Biocare NobelReplace tri-lobe system.
- SwishTapered System: Prosthetically compatible with Straumann Standard and Standard Plus systems. Compatible with the applicable Straumann drills.
- SwishPlus System: Surgically and prosthetically compatible with Straumann Standard and Standard Plus systems.
- SwishActive Implants: Surgically compatible with Straumann Tissue Level drills. SwishActive implants are prosthetically compatible with InterActive 3.0 and 3.4mm abutments and Nobel Biocare conical connection NobelActive™ NP (Narrow Platform – 3.0mm diameter) and NobelActive™ RP (Regular Platform – 3.4mm diameter) titanium abutments. InterActive 3.0 and 3.4mm abutments are prosthetically compatible with Nobel Biocare conical connection NobelActive™ NP (Narrow Platform– 3.0mm diameter) and NobelActive™ RP (Regular Platform – 3.4mm diameter) (3.5-5.0mmD, 8.5-18mmLength)
- InterActive System: Surgically compatible with Nobel Biocare NobelReplace (4.3 & 5.0mmD) and Zimmer Dental Tapered Screw-Vent drills. InterActive implants are prosthetically compatible with InterActive 3.0 and 3.4mm abutments and Nobel Biocare conical connection NobelActive™ NP (Narrow Platform – 3.0mm diameter) and NobelActive™ RP (Regular Platform – 3.4mm diameter) titanium abutments. InterActive 3.0 and 3.4mm abutments are prosthetically compatible with Nobel Biocare conical connection NobelActive™ NP (Narrow Platform– 3.0mm diameter) and NobelActive™ RP (Regular Platform – 3.4mm diameter) (3.5-5.0mmD, 8.5-18mmLength) implants.

3: *Contraindications* include but are not limited to: vascular conditions, uncontrolled diabetes, clotting disorders, anticoagulant therapy, metabolic bone disease, chemotherapy or radiation therapy, chronic periodontal inflammation, insufficient soft tissue coverage, metabolic or systemic disorders associated with wound and/or bone healing, use of pharmaceuticals that inhibit or alter natural bone remodeling, any disorders which inhibit a patient’s ability to maintain adequate daily oral hygiene. *Implant Direct Dental Implants* have not been evaluated for safety and compatibility in the MR environment. *Implant Direct Dental Implants* have not been tested for heating or migration in the MR environment and they are not represented to be “non-pyrogenic.”

4: Surfaces: Implant Direct implants are made of titanium alloy (6Al-4V ELI). The SBM surface is created using irregularly-shaped hydroxylapatite particles to create a medium-rough texture. The HA coating surfaces are achieved via a plasma spray process using hydroxylapatite particles.

5: *Oral contraindications* include but are not limited to: uncontrolled parafunctional habits (e.g. bruxing, clenching, gnawing), insufficient height and/or width of bone, insufficient interarch space, intraoral infection, poor or noncompliant patient oral hygiene.

6: *Single-Use Packaging:*  **Single Use Rx Only** This device is designed for Single Use Only and re-use should not be attempted. The effects of multiple-use have not been clinically or scientifically tested, and there is no data to support that the device will perform as designed after multiple uses.

7: *Sterile Packaging:* **STERILE** Implants and included materials are sold sterile by gamma irradiation. Do not re-sterilize.

8: *Handling:* Implants must be stored in a dry place, at room temperature, in their original packaging. Dental implants are provided in sterile vials mounted to fixture-mounts, carriers, or provided mount-free. The fixture-mount or carrier are intended to

Note 1: Use Swish Drills

Note 2: Use RePlant Drills

10.4: *Insertion Procedure:*

10.4.1: *Patient Information:* Peel off removable label from the outer vial and place the label in patient's chart.

10.4.2: *Open Outer Packaging:* Remove vial cap by turning counterclockwise until the tamper-resistant ring is detached. Pour inner vial which contains the implant onto a sterile tray.

10.4.3: *Remove From Inner Packaging:* All implants are packaged in a sterile plastic inner vial. The fixture mount or carrier is used to remove the mounted implant from the inner vial. For mount-free implants, remove the titanium disc color-coded to the implant prosthetic platform, then utilize the appropriate sterilized insertion tool to remove the mount-free implant from the inner vial.

10.4.3.1: *Titanium Fixture Mount:* Remove the implant assembly from the sterile inner vial and carry it to the implant osteotomy with an appropriate instrument or with powder-free sterile-gloved fingers. Avoid contact with the surface of the implant that will be in contact with bone.

10.4.3.2: *Plastic Carrier:* Remove the implant assembly from the sterile inner vial and carry it to the implant osteotomy with powder-free sterile-gloved fingers. Avoid contact with the surface of the implant that will be in contact with bone.

10.4.3.3: *Mount-free:* Remove the implant from the sterile inner vial and carry it to the implant osteotomy with the appropriate sterilized retentive tool using powder-free sterile-gloved finger. Ensure tool is fully engaged with implant before removing. Avoid contact with the surface of the implant that will be in contact with bone.

10.4.4: *Implant to Site:* Carry the implant to the prepared surgical site and begin threading the implant into place just enough to stabilize it.

10.4.5: *Implant Insertion:* Continue inserting the implant using appropriate instrumentation.

10.4.5.1: *Titanium Fixture-Mounts:* Rotate the fixture mount clockwise until the implant is fully seated into the osteotomy with the roughened surface level with the crest of the bone. Use the appropriate instrumentation to unthread the retaining screw and remove the fixture mount.

10.4.5.2: *Plastic Carrier:* Rotate the implant by the plastic carrier clockwise until slight resistance frees the mount. Remove the carrier and finish seating the implant with the appropriate insertion tool and ratchet. For the ScrewIndirect and ScrewDirect, retrieve the comfort cap from the bottom and press fit onto the top of the implant. Suture the soft tissue around the implant.

10.4.6: *One and Two Stage Healing:*

10.4.6.1: *Cover Screw and Extender:* For two-piece implants, use the appropriate instrumentation and unthread the implant cover screw from the plastic mount located at the bottom of the inner vial and thread into the implant. Some implants are also provided with a 2mm extender for one-stage healing that is retained with a cover screw. Suture the soft tissue over the cover screw or around the 2mm extender.

10.4.6.2: *Fixture Mount /Abutment:* The titanium fixture mount provided with some implants can be shortened to serve as either a titanium temporary or final abutment, reference 4.2.2 below for recommended modification parameters. Using a carborundum disc, separate the colored square from the tapered abutment portion of the fixture mount and attach the abutment to the implant using appropriate torque. For implants packaged with a two-piece fixture-mount, remove the

colored square by hand and shorten the fixture mount at the groove for a functional final abutment to attach to the implant using appropriate torque. Remove the snap-in mount (if included) at the bottom of the inner vial to retrieve the comfort cap and press fit onto the tapered abutment and suture the soft tissue around the comfort cap to maintain the tissue opening for one-stage healing.

10.4.7: *Post-Operative Care:* It is recommended that patients use a suitable mouth rinse and perform regular oral hygiene following surgery.

10.4.8: *Healing Time:* Usually implants are allowed to heal for a period of two to four months prior to being restored depending upon bone quality and type or any compromising medical condition.

10.4.9: *Instructions*  : Users are advised to consult packaged instructions for use and the technical support sections of our website (www.implantdirect.com) for assistance.

Prosthetic Components

In addition to the implant systems previously identified, this section also applies to prosthetic components for the Pitt-Easy and Endopore systems as well as Attachments International

1: *Training:* Implant restoration involves complex procedures and should be performed by dental professionals who have received implantology training in proper techniques. Inadequate training may result in failure of the restoration and further complications.

2: *Packaging:* All abutments and accessories are cleaned and packaged in a Class 10,000 cleanroom environment with the exception of prosthetic components for the Pitt-Easy and Endopore systems and Attachments International which are packaged in a non-cleanroom environment. All abutments and accessories are supplied non-sterile unless they are explicitly marked as sterile. Sterilization is required for all prosthetic components prior to being used intraorally.

3: *Packaging For Sterilization:* Enclose the product in FDA cleared steam sterilizable pouches and sterilize in FDA cleared sterilizer.

3.1: *Sterilization of non-sterile prosthetic components (Titanium, gold, and plastics):* Steam sterilize using a gravity displacement cycle for 30 minutes at 121°C (250°F), 15-20 psig, and dry time: 15 minutes wrapped in a double pouch. Multiple piece products should be disassembled to individual components prior to sterilization.

3.2: Steam sterilize Zirconia abutments using a pre-vacuum cycle for 4 minutes at a temperature of 132°C (270°F) with a dry cycle of 20 minutes double pouched. When sterilizing multiple devices in one steam sterilization cycle, ensure that the sterilizer manufacturer's maximum load requirements are followed.

4: *Insertion Procedures For Abutments:*

4.1: *Patient Information:* For items packaged in vials, peel off removable label from the vial package containing and place the label in the patient's chart.

4.2: *Remove Abutments From Packaging:* All abutments packaged in vials are mounted on a plastic screw mount or carrier.

4.2.1: *Straight and Overdenture Abutments:* Remove the abutment assembly from the outer vial. A comfort cap and colored transfer component are located on the underside of the screw mount. Set these aside to be used later. Remove the abutment from the plastic screw mount by unscrewing the fixation screw with the corresponding driver. When placing the plastic transfer component back onto the abutment for the impression phase, align the flat of the abutment to the flat and

protruding feature found towards the top of the transfer. Press on the transfer until a distinct snap is felt and/or heard, which indicates the transfer is fully seated and ready for the impression phase.

4.2.2: *Angled, Cast-To Gold, Zirconia, and Straight Contoured Abutments and Plastic Temporary Abutments*: Remove the abutment assembly from the outer vial. Remove the abutment from the plastic screw mount by unscrewing the fixation screw with the corresponding driver. If modifications are required, the following must be maintained: a maximum angle of 30° from the axis of the implant, a minimum wall thickness of 0.4mm, a minimum post height of 4mm and a minimum cuff height from the interface of 0.7mm.



The modifiable abutments are intended to be modified only by the company and/or chairside by the dentist using standard hand instruments only.

NOTE: The Plastic Temporary Abutments are intended for use with unloaded conditions for a period of less than 28 days.

4.3: *Placement of Fixed Prosthetic Comfort Caps*: Line up the flat on the comfort cap to the corresponding flat on the straight abutment, or modified fixture mount, and snap into place. For added retention, rotate the cap until a tight fit has been achieved. To remove, rotate cap to realign the flats and pull up. **NOTE:** The use of Comfort Caps should not exceed 28 days.

4.3.1: *Placement of Ball, GPS and Screw-Receiving Abutment Comfort Caps*: Press fit comfort cap into place. No specific orientation of the cap is necessary with these components.

4.4: Proceed with disinfection and sterilization instructions as detailed in item #3 above.

4.5: *Insertion of Abutments*: Abutments are initially seated using the corresponding driver in conjunction with either a fixation screw (straight, scalloped, gold and angled abutments) or by accessing the hex portion of the abutment top (overdenture and ball abutments). Abutments should then be torqued to 30Ncm, unless otherwise specified on the label, to ensure fixation between mating components.

5: *Post-Restorative Care*: It is recommended that patients use a suitable mouth rinse for the first 7 to 10 days following implant restoration. Subsequently, patients should perform regular oral hygiene and maintain regular dental prophylaxis.



6: *Instructions* : Users are advised to consult packaged instructions for use and the technical support sections of our website (www.implantdirect.com) for assistance.

Surgical Instruments and Drills

1: *Description, General*: Surgical instruments and surgical drills are tools used to perform a dental implant or prosthetic surgical procedure following implant indications and contraindications for use. The tools are reusable and are provided non-sterile but are capable of being cleaned and sterilized according to the instructions for use.

1.1: *Description, Surgical Instruments*: Tools comprised of one or more guides, manual torque drivers, handles, wrenches, guide pins, holders, or complementary tools and are used to aid in a surgical implant/prosthetic procedure.

1.2: *Description, Surgical Drills*: Tools comprised of one or more drills used to create an osteotomy, or apply a torque, using an active device.

2: *Packaging*: Surgical instruments are packaged non-sterile. Surgical instruments and drills should be cleaned and sterilized prior to each use.

3: *Cleaning and Disinfection*: Prevent body fluids, hard and soft tissues from drying on the instruments and drills by cleaning as soon as possible after use.

3.1: *Preparation*: Automated cleaning may not be effective. Thorough manual cleaning process is recommended. When applicable, disassemble trays and instruments and drills prior to cleaning.

3.2: *Cleaning and Disinfection*

3.2.1: *Agents*: Cleaning agents containing hydrogen peroxide, chlorine or chloride must not be used as the active agents are corrosive to stainless steel.

3.2.2: *Preliminary Manual Cleaning*: For heavily soiled instruments and drills, or for instruments and drills that have accumulated organic debris, a preliminary manual cleaning is advised. Use a soft brush (no metal bristles) so as to completely remove residue.

3.2.2.1: *Wipe instruments using a soft, disposable non-shedding wipe.*

3.2.2.2: *Soak in lukewarm enzymatic solution for 20 minutes.*

3.2.2.3: *Universal precautions for the handling of contaminated or biohazardous materials should be observed.*

3.3: *Routine Cleaning*

3.3.1: *Wash the instruments using a broad spectrum cleaning solution. Rinse in water and dry thoroughly.*

3.3.2: *Prepare a neutral pH enzyme cleaning detergent solution per manufacturer's instructions and place in a sonication unit.*

3.3.3: *Completely submerge instrument in cleaning solution and sonicate for 10 minutes, preferably at 45-50kHz.*

3.3.4: *Rinse instrument in purified (de-ionized) water thoroughly for at least 3 minutes.*

3.3.5: *Repeat above two steps with freshly prepared cleansing solution.*

3.3.6: *Dry the instrument with a clean, disposable, and absorbent non-shedding wipe.*

4: *Packaging For Sterilization*: Enclose the product in an FDA cleared steam sterilizable wrap and sterilize in an FDA cleared sterilizer.

5: *Sterilization*: Steam sterilize using a gravity cycle for 15 minutes at a temperature of 132°C (270°F) with a dry cycle of 30 minutes. Steam sterilize using a pre-vacuum cycle for 4 minutes at a temperature of 132°C (270°F) with a dry cycle of 20 minutes. To avoid deformation, surgical tray should not touch walls of steam sterilizer. When sterilizing multiple instruments in one steam sterilization cycle, ensure that the sterilizer manufacturer's maximum load requirements are followed.

6: *Storage*: Keep instruments in sterilization packaging and in a dry and clean environment. Maintain packaging integrity. Check before usage.

7: *Instructions*:  Users are advised to consult packaged instructions for use and the technical support sections of our website (www.implantdirect.com) for assistance.

Surgical Tray

1: The trays are intended to be used as an aid for placement of Implant Direct implants.

2: *Description, Surgical Tray:* The surgical tray is designed to hold various dental instruments in order to organize, steam sterilize, and transport them between uses. The tray is to be enclosed in an FDA cleared steam sterilizable wrap and sterilized in an FDA cleared sterilizer using the sterilization method specified below. The following information applies to the surgical trays; the trays are intended for sterilization of non-porous loads, and the trays are recommended not to be stacked during sterilization.

3: *Preparation for Use:* The Surgical Tray, and its accompanying instruments if any, are packaged non-sterile and should be cleaned and sterilized¹ prior to each use. When applicable, disassemble trays and devices prior to cleaning.



Cautions: Universal precautions for the handling of contaminated or biohazardous materials should be observed. The Surgical Tray is not designed for cleaning and disinfection in the fully assembled state. The instruments must be removed from the tray for adequate cleaning results.

4: Processing Instructions

4.1: *Point of Use:* Directly after use, wipe excess soil from tray and instruments using disposable lint free cloth to remove gross soil.

4.2: *Transportation to Processing Area:* Minimize the time before manual cleaning and reprocess as soon as practical following use.

4.3: *Preparation for Manual Cleaning:* Disassemble the tray into its individual components: base, lid, and (if applicable) insert. If tray comes with accompanying instruments, remove from tray, clean and disinfect separately before sterilizing in assembled state. Note: Refer to assembly/disassembly instructions for the tray in appendix section.

4.4: Manual Cleaning²:

4.4.1: Prepare concentrate enzymatic detergent as per manufacturer's recommendation at 1/8 oz. per gallon (0.98mL per L) of lukewarm tap water.

4.4.2: Immerse the disassembled tray in the detergent and soak for 10 minutes.

4.4.3: Prepare neutral detergent as per manufacturer's recommendation at 1/8 oz. per gallon (0.98mL per L) of tap water.

4.4.4: Immerse tray in the detergent and soak for 2 minutes.

4.4.5: Remove tray from detergent and rinse under running tap water.

4.4.6: Dry tray with disposable, lint free cloth.

4.4.7: Prepare concentrate enzyme detergent according to manufacturer's recommendation at 1/8 oz. per gallon (0.98mL per L) of warm tap water in a sonicator.

4.4.8: Immerse tray into the detergent and sonicate for 10 minutes.

4.4.9: Remove tray and rinse in bath of reverse osmosis/deionized water (RO/DI) water for a minimum of three minutes. Repeat these steps 3X with fresh RO/DI water each time.

4.4.10: Dry tray using disposable lint free cloth.

4.5: *Inspection:* Visually inspect tray for visible soil. If fluid or tissue build-up is present, repeat cleaning procedures.

4.6: *Packaging for Sterilization:* Prepare tray for sterilization, with or without instruments, by double wrapping with FDA cleared steam sterilizable wrap.

4.7: *Sterilization:* The wrapped tray is to be sterilized in an FDA cleared sterilizer for one of the following cycles: Steam sterilize using gravity cycle for 15 minutes at a temperature of 132°C (270°F) with a dry cycle of 30 minutes. Steam sterilize using pre-vacuum cycle for 4 minutes at a temperature of 132°C (270°C) with a 20 minute dry time, 4 pulses.

4.8: *Storage:* To maintain the integrity of sterility, keep the wrapped article in a dry and clean environment. Check before usage.

5: Limitations of Reprocessing:

5.1: Proper processing has minimal effect on the tray. End of life is determined by wear and damage due to wear.

5.2: Do not leave tray and instruments in solutions longer than necessary. This may accelerate normal product aging.

5.3: Do not use cleaning agents containing hydrogen peroxide, chlorine or chloride. The active agents are corrosive to the instruments. Using a detergent outside of the recommended pH may adversely affect the finish of the tray.

6: *Sterilization Tray Setup:* The combined weight of the tray with instruments is less than 25 pounds when the containment device load is configured according to manufacturer's instructions thus allowing sterilization as per ANSI/AAMI ST77.

7: *Lumen Claims:* Implant Direct Sybron Manufacturing LLC does not make any lumen claims for the Surgical Tray.

Note 1: Cleaning and sterilization instructions validated by Implant Direct Sybron Manufacturing LLC as per AAMI TIR 12, AAMI TIR 30, and FDA draft guidance document for processing/reprocessing medical devices in health care settings.

Note 2: Cleaning: Prolystica 2X concentrate Enzymatic Detergent and Prolystica 2X neutral pH detergent were used to validate the manual cleaning process as per the manufacturer's dilution instructions. Cleaning validations were performed using the micro BCA protein assay with device extraction. Process validation consisted of contamination, cleaning, and sterilization. The haemoglobin level was well below the acceptance criteria level of <2.2 ug/cm². The protein level was well below the acceptance criteria level of 6.4 ug/cm².

Appendix:

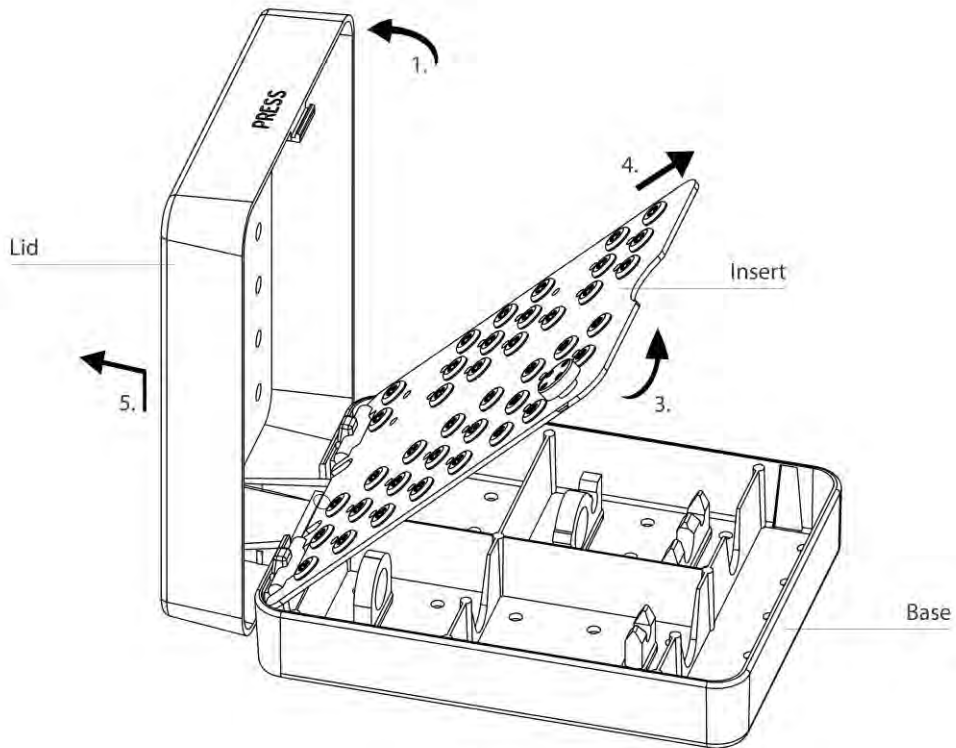











Disassemble:

1. Open the lid of the tray and fold back.
2. Remove instruments from the insert, if any.
3. Rotate the insert up and unsnap the insert from the base.
4. Remove the insert from the assembly.
5. Unsnap the lid from the base to disassemble.

Assemble:

1. Snap on the lid to the base and keep both the parts perpendicular to each other.
2. Place the insert in between the base and the lid and snap in.

3. Assemble instruments in the insert, if needed.
4. Close the lid by lowering the lid. It automatically locks on to the base when lowered.

	Manufacturer's symbol
	Use by date
	CE mark
	Sterilized using gamma irradiation
	Do not re-use
Rx Only	Caution: Federal law restricts this device to sale by or on the order of a dentist
	Consult instructions for use
	Do not use if packaging is damaged
	Caution
	Reference/Product Code number
	Caution: Not Sterilized
	Authorized Representative in Europe



Authorized Representative in Europe
Emergo Europe
Molenstraat 15 2513 BH The Hague Netherlands

IFU-001 Rev-16